



# Dacorum Strategic Design Guide

## Part 3: Employment Uses Guidance

Supplementary Planning Document

February 2021



This document was developed collaboratively by

Dacorum Borough Council,

St Albans City & District Council,

HertsIQ,

Proctor & Matthews Architects, and

David Lock Associates.

Where not otherwise credited, all images are © Proctor & Matthews Architects

# Contents

## 4 Introduction

- 4 Employment Uses Guidance
- 5 How to Use This Guide

## Employment Uses Guidance

### 6 Employment Design Principles

- 6 E1. A Healthy Place to Work and Socialise
- 10 E2. A Multi-Functional, Natural Environment
- 14 E3. A Sustainable Built Environment
- 18 E4. A Well Connected, Integrated Place
- 20 E5. A Pedestrian Focused Place
- 22 Example in a Wider Framework

### 23 Building Typologies

- 23 Building Typologies - Industrial and Offices
- 24 Small Industrial Units
- 25 Large Industrial Units
- 26 Industrial Units: Best Practice Examples
- 28 Small Office Units
- 29 Large Office Units
- 30 Office Units: Best Practice Examples

# Employment Uses Guidance

This document is the third part of the Dacorum Strategic Design Guide Supplementary Planning Document (SPD) outlining Dacorum's expectations for high quality design. This document provides detailed guidance on the design of employment uses.

## Employment Uses Guidance

This document provides guidance to secure contemporary employment development which adheres to best practice environmental sustainability measures, offers a diverse and flexible range of high quality commercial spaces for different businesses, and coherent, attractive public spaces and streets which encourage healthy working lifestyles and social interaction.

The guidance has been developed in collaboration with Hertfordshire Innovation Quarter and will be used to promote the highest possible design quality for the Enterprise Zone.

## Application of the Guidance

The design guidance in this document applies to any applications for Business (B1), General industrial (B2) and Storage or distribution (B8) uses in excess of 1,000 m<sup>2</sup> GIA.

## Relationship with Part 1 Design Process

Design for employment uses should follow the design process set out in the Dacorum Strategic Design Guide Part 1. For large sites, employment areas should be designed as part of an overall masterplan framework as illustrated to the right.

## Relationship with Part 2 Design Principles

The Dacorum Strategic Design Guide Part 2 defines the strategic design principles which are to be applied across sites of all scales and which should underpin design at all stages, from site-wide masterplanning to the design of blocks, buildings and streets. Proposals for employment uses will be expected to demonstrate how they adhere to all general Design Principles which are relevant in addition to the Employment Design Principles contained within this document.

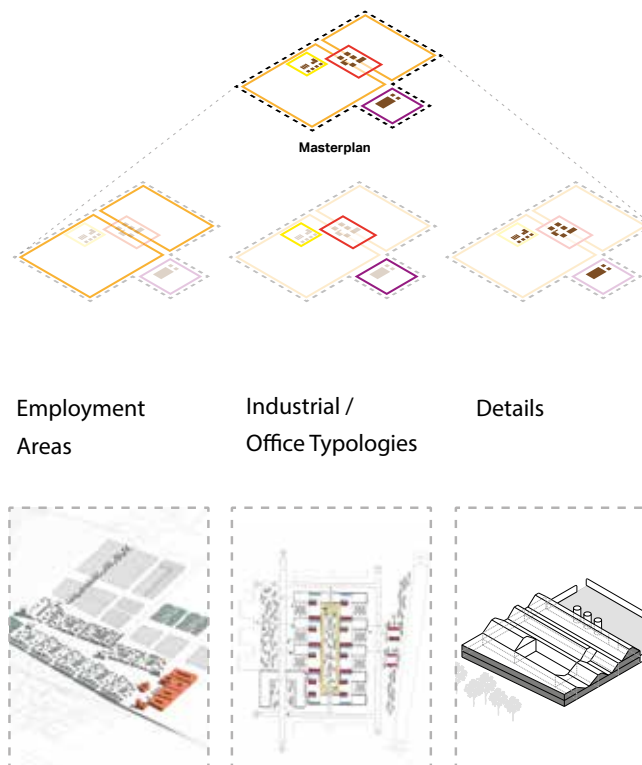

Maylands Business Centre, Hemel Hempstead. Photo: DBC

# How to Use This Guide

## Guidance Structure

### Employment Design Principles

The first section of this document addresses design principles that apply to any employment area regardless of its size or use classes. These design principles are illustrated with case studies demonstrating best practice examples.

These design principles are bespoke to employment areas, and should be applied in addition to the general Design Principles set out in Part 2 of the Dacorum Strategic Design Guide.

### Building Typologies

The second section provides design solutions, tailored to large and small business and industrial units, which address commonly-encountered challenges of parking, servicing and relationship to the public realm and ensure that these units can meet the employment design principles. Design solutions are also illustrated with best practice examples.

## Principle of 'Comply or Justify'

The Strategic Design Guide is to be used following a principle of 'Comply or Justify'. Deviation from the principles and design processes set out will only be permitted with robust and evidence-based justification for doing so. In such cases, developers and their design teams must demonstrate that their proposals will deliver the very highest quality design that aligns with the aims of each Design Principle theme. Proposals that do not comply with these principles and fail to provide compelling justification, including evidence and options analysis, will be refused.

## Key

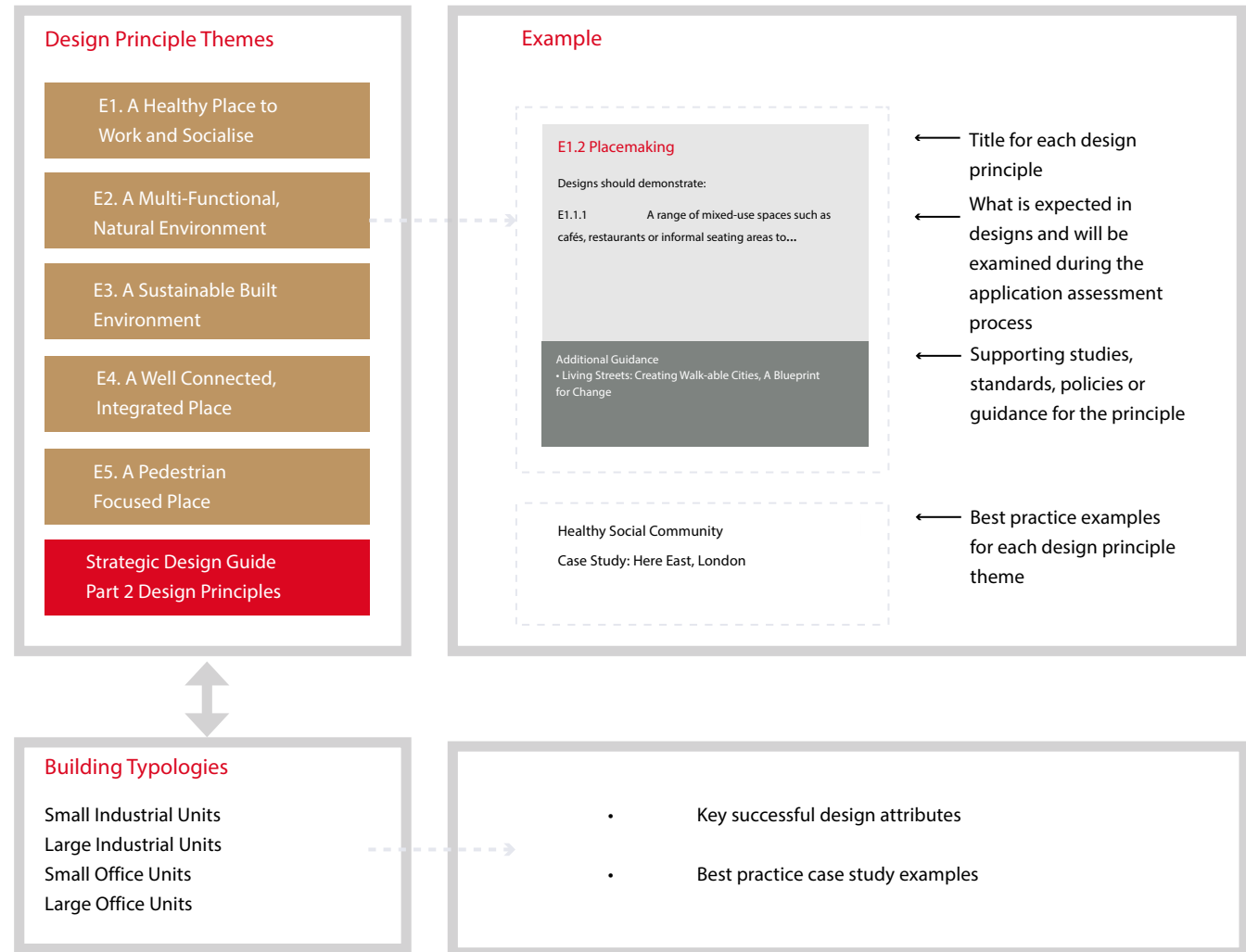

# E1. A Healthy Place to Work and Socialise

## Overview

Employment areas should be enjoyable and pleasant places for people to work, in order to attract businesses and their staff. There should be a focus on placemaking and also on health and well-being.

Designers should create varied and engaging sites, that also serve local residents by providing facilities and open space/public space, which thereby encourage interaction between the new employees.

## E1.1 Placemaking

Designs should demonstrate:

E1.1.1 A range of mixed-use spaces such as cafés, restaurants or informal seating areas to strengthen the connection between the employment area and adjacent residential areas.

E1.1.2 Shared workspaces for meetings and collaboration between the users of different commercial units, to be provided either within the individual units or as part of the wider employment area.

E1.1.3 Community focused social hubs at the heart of schemes to invite the community in.

E1.1.4 A public realm that incorporates the smart use of internet and outside areas for working with Wi-Fi connections.

## E1.2 Health and Well-being

Designs should demonstrate:

E1.2.1 'WELL Building' standards for all commercial buildings.

E1.2.2 A comprehensive network of safe and attractive connections to surrounding pedestrian and cycle routes, public transport and key destinations beyond the site.

E1.2.3 Opportunities for informal exercise and physical activities such as petanque, table tennis or fitness stations, to be provided as part of any indoor communal facilities and in the public realm.

E1.2.4 Formal sport courts located within the public realm to encourage social interaction between the different users of the commercial areas, as well as adjacent residents.

E1.2.5 That amenity impacts to nearby residents and other uses and users have been mitigated and/or minimised. These may include noise, vibration, fumes, visual and lighting impacts.

E1.2.6 Consultation with the appropriate stakeholders and any necessary measures for health and safety.

Additional Guidance:

<https://www.wellcertified.com/certification/v2/>

# Best Practice Examples: A Healthy Place to Work and Socialise

Healthy Social Community  
Case Study: Here East, London

Facing the Queen Elizabeth Olympic Park is 'The Gantry' - a gridded structure of bespoke sheds home to independent artists, designers and craftspeople.

Creative businesses based in Hackney and neighbourhoods nearby can occupy spaces in Here East, making it a valuable part of the local community.

At the centre of the scheme is the yard, a flexible space that can accommodate an outdoor cinema, public markets and a public events space for the local community.

At one end of the yard is the auditorium, which is used for talks, screenings, exhibitions and cultural events for the local community.

A strong link has also been created with the community of nearby Hackney Wick. Encouraging independent bakers, brewers and restaurants into units adjacent to the canal, has created an area of social exchange.

Here East, Stratford. Hawkins\Brown. Photo: Jason Hawkes



Photo: Rory Gardiner



The 'Olympic' Park facing façade has a number of modular artist studios for the community to use.

Photo: Rory Gardiner



New auditorium at the centre of the scheme holds talks and cultural events for the local community

Photo: Rory Gardiner



Area of social exchange along the canal between the new restaurants and the existing community opposite

# Best Practice Examples: A Healthy Place to Work and Socialise

## Community Activation

Case Study: Chiswick Park, London

Chiswick Park's office buildings all front onto its central landscaped area, meaning its users actively engage with the public realm and those who share it.

The buildings towards the centre of the scheme are set back in a way that allows the public realm to be contained on all sides by active building frontages.

A central square sits at the heart of the landscaped area, with tiered seating around the outer edge. A number of events are hosted at this central square, encouraging the engagement and investment of the Park's users in its community.

Photo: Chiswick Park Enjoy-Work



Chiswick Park central square hosting pop up events



Key:

- Central square
- Active frontages that face the square

Plan showing the buildings set around the central square



# Best Practice Examples: A Healthy Place to Work and Socialise

## WELL Certification

Case Study: Green Park, Reading

Green Park is registered to pursue WELL Certification through the International WELL Building Institute. 400 and 450 Longwater Avenue will be the first buildings to achieve this certification. The seven concepts of WELL are air, light, nourishment, comfort, mind, fitness and water.

## Shared Social Spaces

Case Study: Cambridge Science Park

The Bradfield Centre is a co-working space and acts as the central hub for Cambridge Science Park. It has an outdoor lakeside pavilion which sits in-between the two arms of public realm. This pavilion has tiered seating and Wi-Fi to encourage working outside as well as a cross-fertilisation of ideas between workers.



Bradfield Centre. Photo: Stace LLP

Lakeside pavilion with outdoor tiered seating

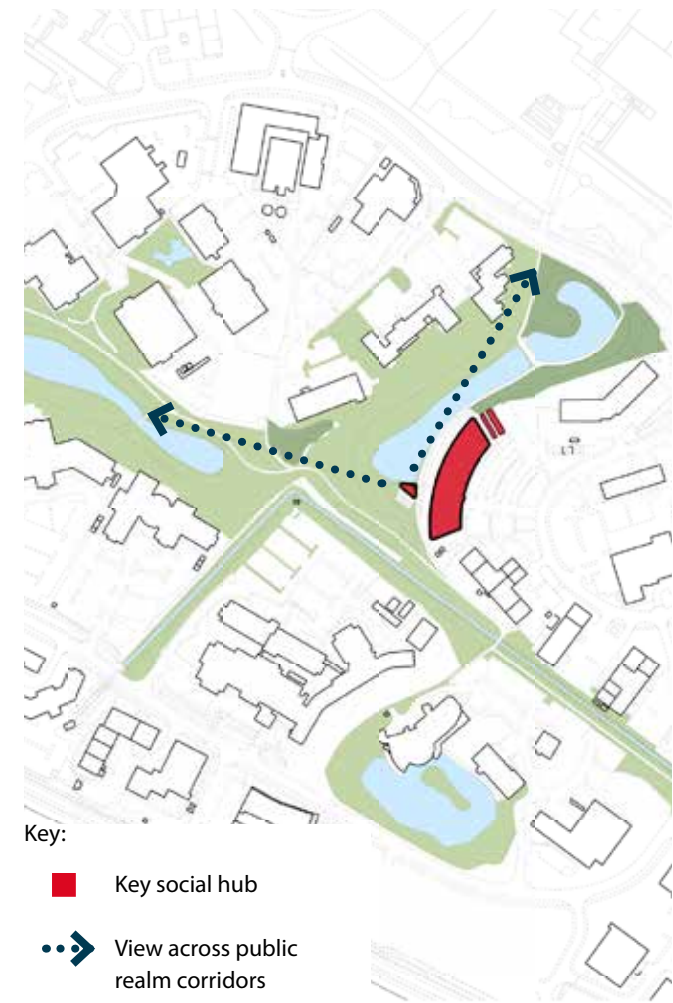

Key:

■ Key social hub

➤ View across public realm corridors

The Bradfield Centre (red) sits at the heart of the public realm

## E2. A Multi-Functional, Natural Environment

### Overview

Sustainable and innovative blue and green infrastructure can help tackle climate change while also increasing the variety of spaces within a development, thereby improving the area as a place.

The new employment areas should be places that are sustainable and inspire and encourage residents and businesses to contribute towards the success of places in environmental terms.

### E2.1 Environmental Sustainability

Designs should demonstrate:

E2.1.1 A strategy for integrated Sustainable Drainage Systems (SuDS) and green roofs with the aim of achieving green field run off rates, while contributing to increased biodiversity and improving water quality of surface water run-off.

E2.1.2 Surface and rainwater harvesting for both individual units and the public realm. The harvested water could be re-used within buildings and for the irrigation of the landscaped areas.

E2.1.3 That the landscape and building strategy enhances the air quality and reduces pollution levels across the site, and adequate arrangements are made for the management of waste and emissions and control of all forms of pollution.

E2.1.4 Innovative forms of green architecture that incorporate food production thereby reducing 'food miles' and reducing packaged waste. Methods could include rooftop gardens and vertical gardens, or orchards could be incorporated into the public realm.

### E2.2 Biodiversity

Designs should demonstrate:

E2.2.1 The retention and enhancement of areas of the site that have a high ecological value, and the creation of additional ecological value.

E2.2.2 A landscape strategy that encourages the use of suitable local plant species that support and enhance the biodiversity of the site whilst also being climate change tolerant.

E2.2.3 SuDS can provide areas of increased biodiversity, such as by the incorporation of wetland plant species.

E2.2.4 Implementation of bird boxes, bee hives, bug hotels.

E2.2.5 Low maintenance planting design, such as wild flower verges. Grass lawns should generally be avoided as high-maintenance and low-biodiversity solutions.

E2.2.6 A substantial increase in tree coverage, including regular street tree planting, planting to car parks and dense vegetation buffers, to create pollution barriers.

# Best Practice Examples: A Multi-Functional, Natural Environment

Sustainable Urban Drainage System  
Case Study: Chiswick Park, London

Water run off is completely contained within the site, and the lakes and waterfall at the centre of the scheme are displayed as visible elements of the sustainable urban drainage system.

Rooftop run-off drains into the lake and the lower lake has been designed to fill up during times of increased run-off.

Office units are all focused around the lakes. Pedestrian routes run parallel with the length of the lakes and at the centre, a bridge cuts across this, joining the two sides.



Photo: DBC

Local example of sustainable drainage paving in Dacorum

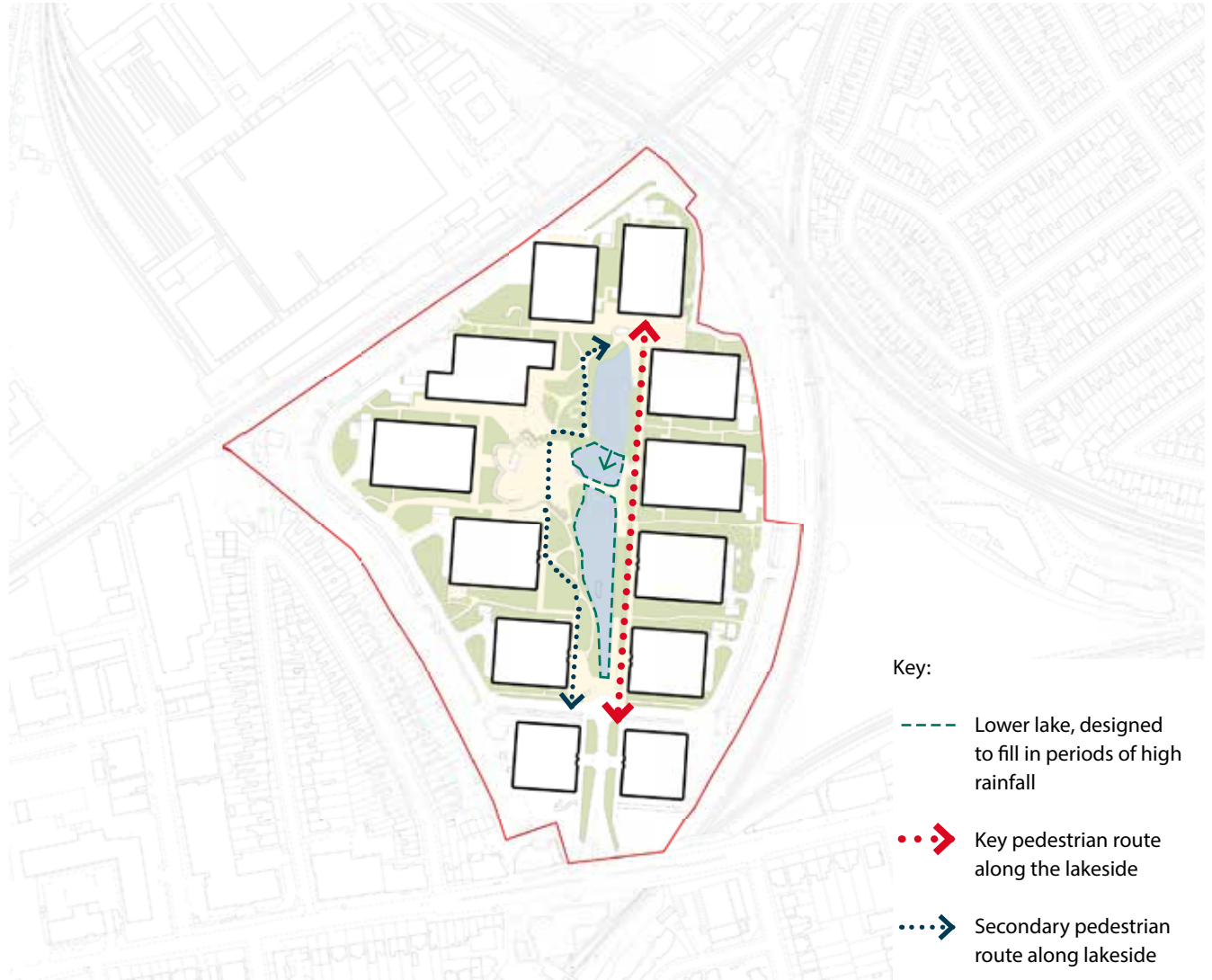

Plan showing landscape, permeability and public routes centred around the lakes

# Best Practice Examples: A Multi-Functional, Natural Environment

Creation of Multi-Purpose Habitats  
Case Study: Cambridge Science Park

A central, protected zone of landscape includes three large lakes and wetland shrubbery to help absorb rainwater and manage the risk of flooding.

Ecological value has been added to the park in the form of summer flowering perennials and ornamental grasses to support and nurture the local population of bees.

Photo: CSA Environmental



Summer flowering perennials and ornamental grasses within the Cambridge Science Park support local bees

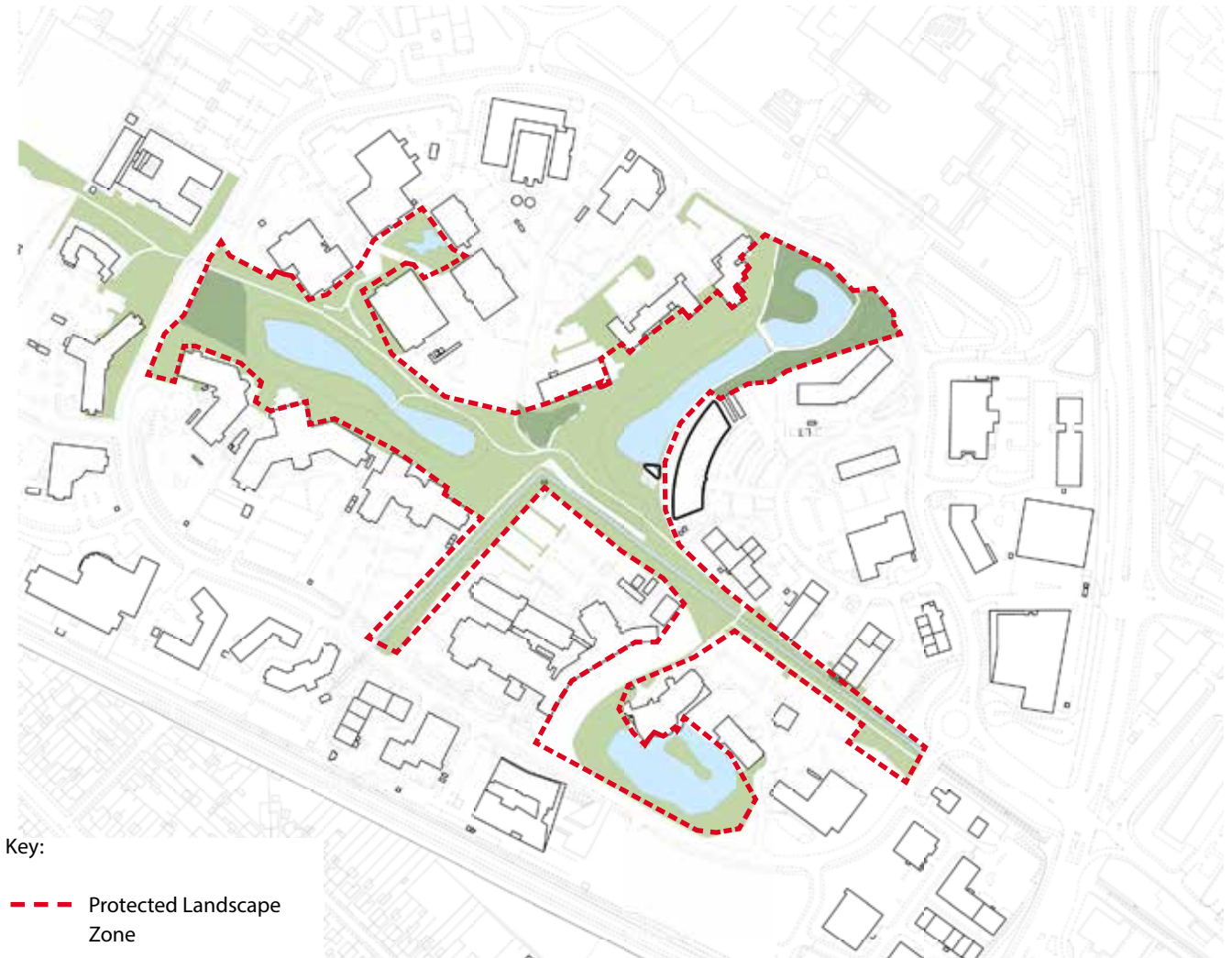

Key:

--- Protected Landscape Zone

Protected, central green landscape with lakes at Cambridge Science Park

# Best Practice Examples: A Multi-Functional, Natural Environment

## A Productive and Sustainable Landscape Corridor Case Study: Green Park, Reading

All of the office units are organised around the central, linear corridor of public realm. A network of footpaths run along Green Park's landscape corridor, giving public access to the range of habitats on site. Within this landscape corridor there is a herb / vegetable garden producing foods such as courgettes, tomatoes, chillies and various herbs that are then used at the park.



## Rainwater Management Case Study: Green Park, Reading

The central lake feature, Longwater Lake, acts as a flood relief channel for the area whilst also providing vital biodiversity to the development. To future proof Green Park and reduce flood risk, the development is on platforms set above the 1 in 200 annual probability level.

Photo: Paul Grudy, Place Design Planning



## Habitat Creation and Enhancement Case Study: Green Park, Reading

An area that was previously poor quality agricultural land has been enhanced, to support a wide range of natural habitats. Numerous bird hides have been set up along the landscape corridor to encourage people to interact with wildlife in the new landscape provided.

Photo: Place Design Planning



## E3. A Sustainable Built Environment

### Overview

From the outset of the design and planning process, a clean and green energy hierarchy should be adopted to ensure the buildings created provide users with high quality and sustainable working conditions.

Integrating sustainable and innovative 'smart initiatives' at the forefront of the design, will not only attract people to work in the area but also to contribute and invest in its vision.

### E3.1 Energy Efficiency

Designs should demonstrate:

- E3.1.1 Innovative strategies for energy generation such as buildings orientated to maximise opportunities for solar energy.
- E3.1.2 Reducing the development's use of resources across its life cycle, including during the construction phase. Low-carbon and recycling targets should be included in development contracts.
- E3.1.3 Prioritising low-carbon solutions and offering high levels of insulation, energy saving measures, natural ventilation and use of renewable energy.
- E3.1.4 BREEAM Standards Design certificates of a minimum level of 'Very Good' for buildings below 1000 square metres and specifying a minimum BREEAM level of 'Excellent' for each non-residential building of 1000 square metres and above.
- E3.1.5 Route toward achieving zero-carbon buildings. This may be achieved through certification such as Passivhaus or appropriate carbon offsetting.

Additional Guidance:

<https://www.breeam.com/discover/technical-standards/communities/>

### E3.2 Efficient Use of Resources

Designs should demonstrate:

- E3.2.1 Reducing vehicular emissions from material transport by using local materials and local manufacturers.
- E3.2.2 Enabling circular economies of use, recovery and re-use with waste or materials recycling facilities.
- E3.2.3 Create a built environment that supports free-cycle events, repair shops and swap shops, to make it easier to exchange goods and reuse products.
- E3.2.4 Create a built environment that supports sustainable waste methods that would reduce the number of waste collections that vehicles make.

# Best Practice Examples: A Sustainable Built Environment

## Energy Generation Through PV Panels

Case Study: Gelsenkirchen Science Park, Germany

The Gelsenkirchen Science Park in Germany features a 300-metre-long glazed building with a series of office tracts protruding off of it. On the roof of the building is a solar power plant featuring a Photovoltaic system which generates sustainable and renewable energy.

Photo: kiessler architekten gmbh

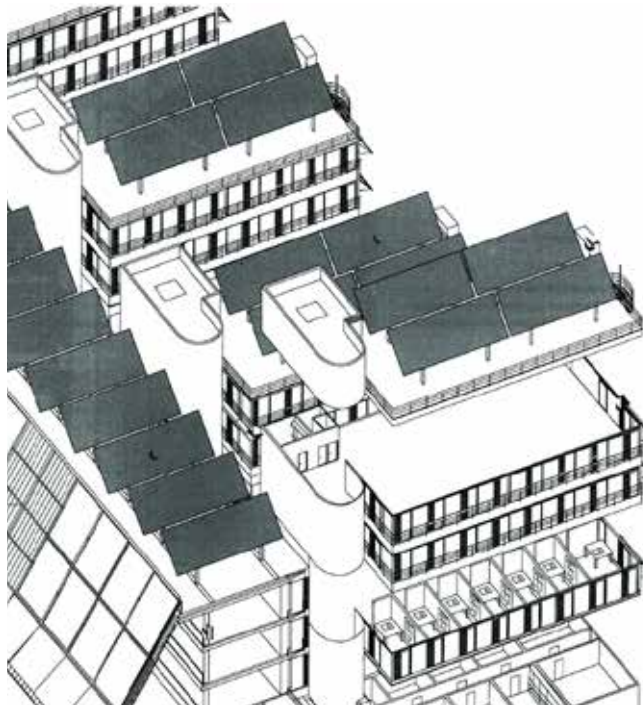

Roof mounted PVs, Gelsenkirchen Science Park, Kiessler + Partners Architects.

## Reduced Energy Consumption Through Innovation

Case Study: Gelsenkirchen Science Park, Germany

The tilted west-facing wall of glass is designed to maximise solar gain. To limit solar overheating, there is external shading mounted on electric motors as well as sheets of glass mounted on larger electric motors, all powered by the solar PV power plant on the roof.

By having the sheets of glass set on motors, the entire 300 metre arcade can be naturally ventilated by air that has undergone evaporative cooling having passed over the artificial lake to the west of the façade.

Photo: kiessler architekten gmbh



Tilted and interactive glass façade at the Gelsenkirchen Science Park, with PV Solar Plant on the Roof

# Best Practice Examples: A Sustainable Built Environment

BREEAM Excellent Certification Through Innovation  
Case Study: Here East, London

The architects delivered optimised solar control through the envelope whilst maximising views and daylight, by creating a ceramic frit to the glass generated by parametric data.

There are also solar PV panels (red on the image below) on the roofs of two of the buildings, providing the site with up to 10% site wide renewable energy.

Here East, Stratford. Hawkins\Brown. Photo: Rory Gardiner / GG Archard



Aerial diagram (top) and innovative façade (bottom)

Reduced Energy Consumption  
Case Study: Green Park, Reading

Building design at Green Park incorporates horizontal louvres on the southern façade to reduce heat gain from sunlight and its associated energy consumption.

Longwater Avenue, GreenPark. NHA. Photo: Martin Charles



Horizontal louvres at 300 Longwater Avenue

Sustainable Energy Generation  
Case Study: Green Park, Reading

At 125m tall, the 2MW state-of-the-art electricity turbine produces electricity which feeds straight into the National Grid. About 70% of energy generated gets used in a two square mile radius around the turbine. The wind turbine also has a visitor centre that can be visited by schools and groups, promoting and educating on sustainable energy.

Place Design Planning. Photo: Paul Grudy



Wind turbine viewed from the landscape corridor



# Best Practice Examples: A Sustainable Built Environment

## An On-Site Wormery

Case Study: Chiswick Park, London

An on-site wormery houses 100,000 worms, capable of breaking down 50kg of food waste per day, thereby reducing the number of collections by emission producing vehicles.

## Reduced Energy Consumption

Case Study: Chiswick Park, London

Fully glazed façades maximise views and daylight and are managed through the use of retractable fabric blinds on the east and west elevations. These blinds operate automatically via roof mounted light sensors.

In addition, fixed external sunshades in the form of a canopy of louvres at roof level help shade the building

surfaces as well as the external spaces directly outside of the buildings, meaning people can work outside more comfortably without the risk of glare and direct sunlight.

A displacement heating and cooling system, along with extensive natural ventilation, significantly reduces the need for air conditioning.

Photo: Chiswick Park Enjoy-Work



Solar shading at Chiswick Park

Photo: Grant Smith, Courtesy of Rogers Stirk Harbour + Partners



## E4. A Well Connected, Integrated Place

### Overview

Sustainability cannot be strengthened significantly without a substantial part of the transport system moving to 'green mobility'. This means travelling by foot, bike or any form of sustainable public transport. These forms of transport are beneficial not only to the environment, but also to the economy through reduced resource consumption.

### E4.1 Connectivity

Designs should demonstrate:

E4.1.1 That the employment area should be physically and visually integrated with the existing natural and built environment.

E4.1.2 The employment area should be easily accessible for all modes of transport, with good connectivity to nearby places, neighbourhoods and mainline rail stations. There should be public transport stops in strategic locations and in close proximity to major buildings or 'hot spots'.

### E4.2 Smart Mobility

Designs should demonstrate:

E4.2.1 Rapid charging points in key areas with provision of designated Electric Vehicle parking bays in accordance with Dacorum's Parking Standards SPD.

E4.2.2 Measures that give priority to sustainable transport modes such as electric bikes, electric taxi services and park and ride schemes into the area.

E4.2.3 Provision of last-mile solutions such as bike sharing services with dedicated bike stations or short shuttle bus services from stations.

E4.2.4 Dedicated cycle lanes / routes and secure cycle storage, as well as showers provided in workspace buildings to encourage people to safely and easily cycle to work.

E4.2.5 Digital infrastructure that allows for the use of smart mobility applications.

# Best Practice Examples: A Well Connected, Integrated Place

## Connections with the Existing Community Case Study: Here East, London

Here East is well connected to the existing and new residential communities in the area. Bridges link the existing Hackney Wick community to the canal side shops at Here East. Cycle routes also link Here East to the new residential developments to the east of the Queen Elizabeth Park. A free 5 minute shuttle bus runs from Stratford Station to Here East.

Here East, Stratford. Hawkins\Brown. Photo: CG Archard



Cycling / pedestrian routes (top). Local example of shuttle buses at Maylands Business Park (bottom. Photo: DBC)

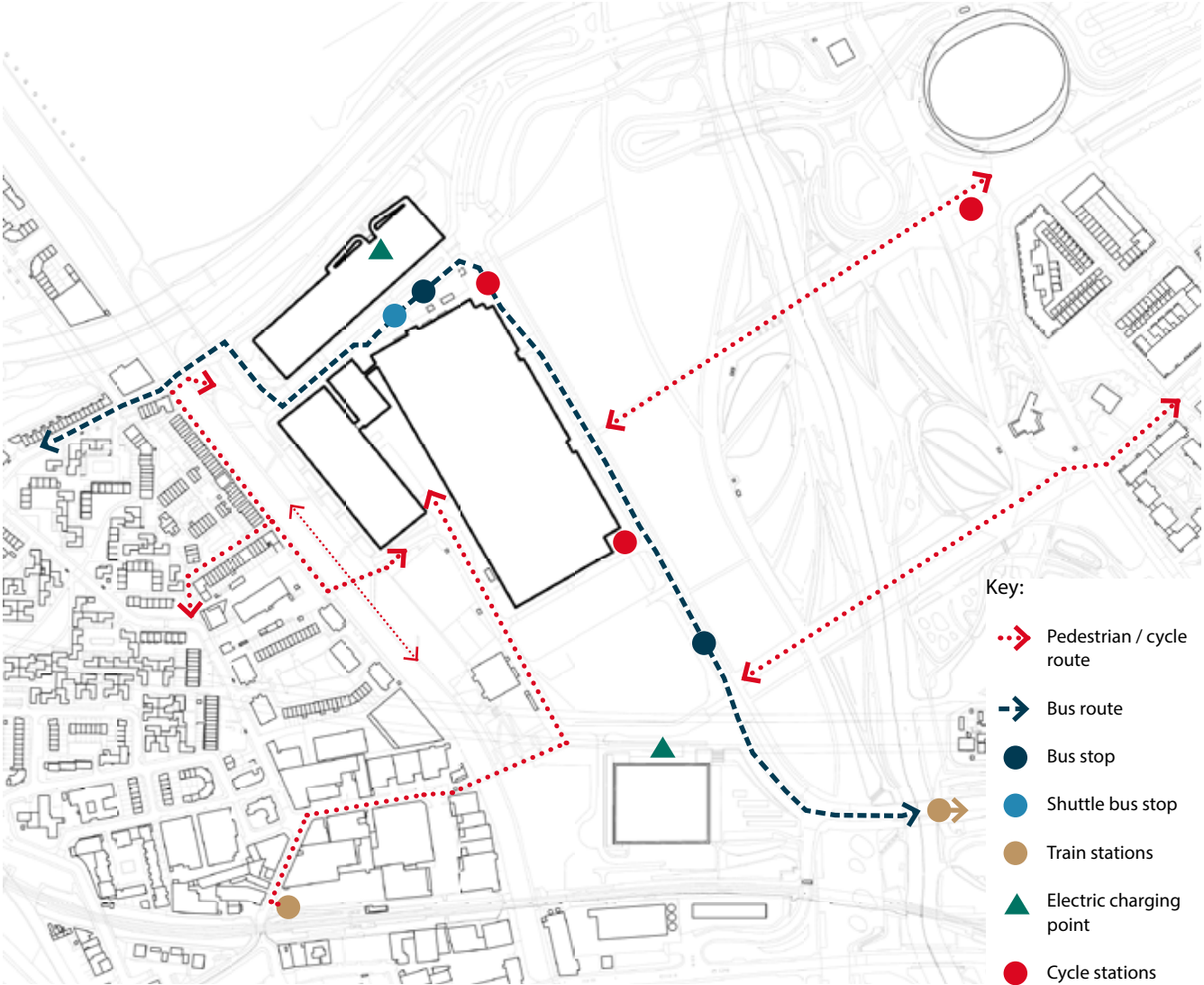

Plan showing the transport links to adjacent areas

# E5. A Pedestrian Focused Place

## Overview

Designs should create a pedestrian focused place by taking into account changing transportation habits and planning for these accordingly. See E4.2 Smart Mobility.

However at the outset of the design process, consideration should also be given to the strategic positioning of vehicular circulation and access, servicing and parking, so that it does not dominate the street and the public realm.

## E5.1 Access and Circulation

Designs should demonstrate:

E5.1.1 Wherever practicable all main vehicular circulation and servicing access should be discretely located at the rear of the buildings and kept separate from the pedestrian and cycle network.

E5.1.2 Vehicular access and circulation should be located away from the main entrances and screened by landscape with the aim to provide a safe and tranquil environment for employees and visitors alike.

E5.1.3 HGV access should be located close to the building whilst at a safe distance from any pedestrian or cycle routes.

E5.1.4 Shared servicing access and service yards can be utilised in order to minimise the impact on the building frontages and the public realm.

## E5.2 Parking

Designs should demonstrate:

E5.2.1 Parking that has a minimal visual impact on the proposed townscape and landscape environment. In order to achieve this parking ought to be concealed either under the units or at the back of the units hidden by walls, screens or landscape.

E5.2.2 Smaller numbers of parking spaces could be arranged into dedicated parking areas that are screened within the landscape and thus less visually intrusive in the public realm.

E5.2.3 Adequate numbers of safe sheltered cycle parking including electric charging points need to be provided for both employees and visitors. Cycle parking should be designed in prominent locations close to building entrances to prioritise cycling over vehicular movement

E5.2.4 Car barns can be implemented in order to ensure the majority of the public realm is vehicle free and of a pedestrian focus.

# Best Practice Examples: A Pedestrian Focused Place

Concealed Parking  
Case Study: Chiswick Park, London

Designed for pedestrian priority (75 percent of those working at Chiswick Park arrive on foot, by bicycle, bus or train), all vehicular activity is routed around the edge of the site, to screened car parks or under-crofts beneath the buildings. These undercroft spaces are neither open to, nor visible from, the front elevations.



Parking concealed underneath the buildings

Chiswick Park, Hounslow. Rogers Stirk Harbour & Partners



Plan showing the parking arrangement within the scheme

# Employment Area: Example in a Wider Framework - Mountfield Park

## Employment

Mountfield Park contains 10,000m<sup>2</sup> of business space, and provides the potential for over 3,700 jobs with the aim of becoming a major business focus within east Kent.

The employment area is set within high-quality strategic landscape and has convenient access to high quality public transport and local shops.

Flexible, modern and affordable business space will ensure Mountfield Park meets a range of needs, from small start-ups to expanding companies and regional HQs.

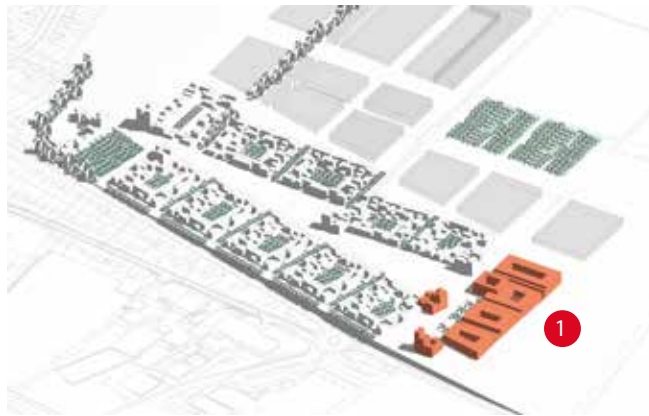

These employment / commercial zones are strategically located within the framework. An example of this is shown above (labelled 1), whereby commercial units are integrated within a residential area.

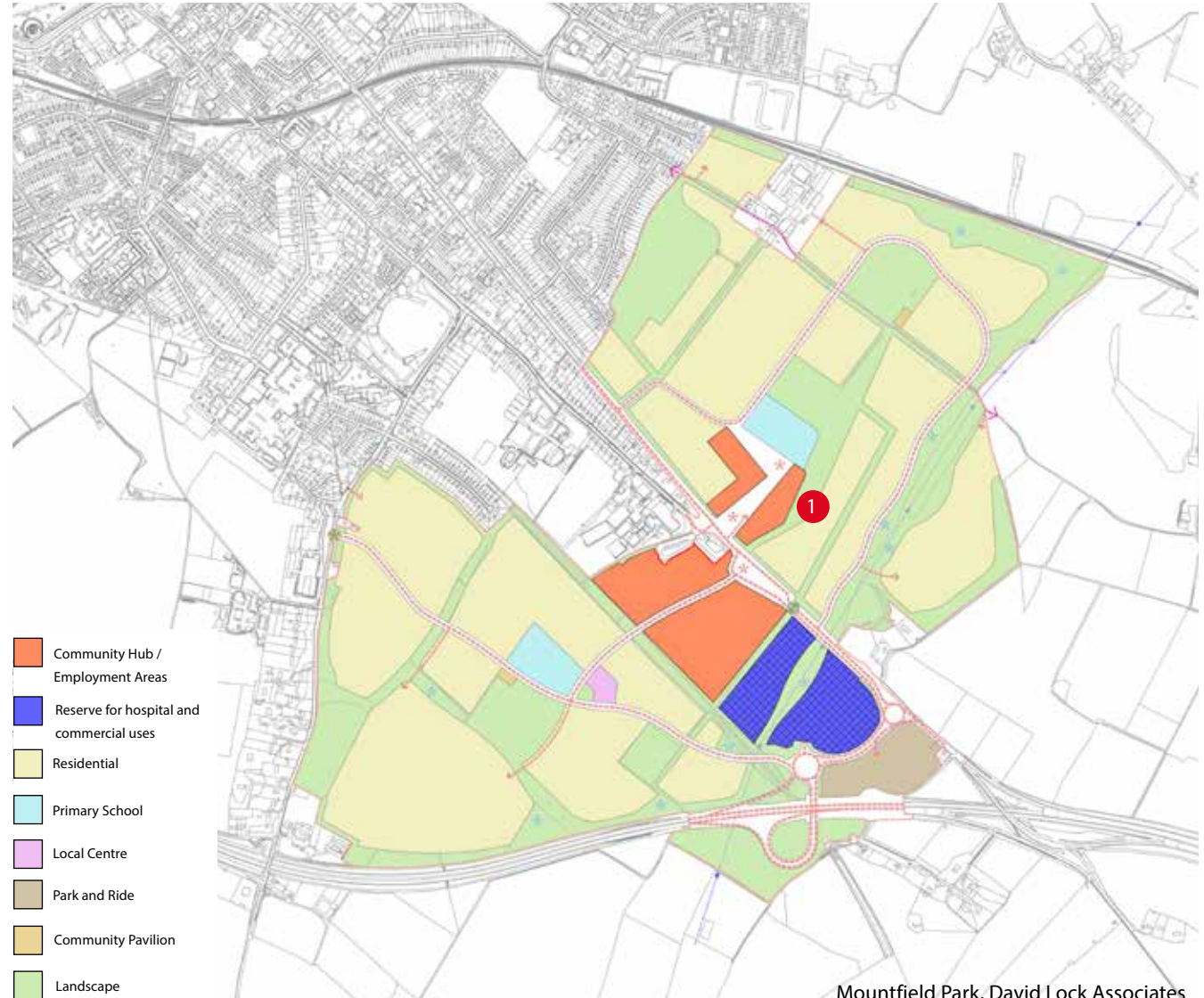

Mountfield Park, David Lock Associates

# Building Typologies: Industrial and Offices

## Small Industrial Unit

Typically consist 'light industrial' uses. These are small to medium sized operations requiring less space and power.



## Small Office Unit

Smaller office buildings hosting a few companies (or even one). Typically these units have some sort of shared circulation / amenity space for the companies to use.



## Large Industrial Unit

Typically consist of 'general industrial' uses. Normally medium to large scale batch production and assembly of components requiring more space and power.



## Large Office Unit

Larger office buildings hosting multiple companies, often with dedicated floors and multiple shared facilities to use. These units often need dedicated space for servicing.



## Key Outputs

- Site layout
- Landscape drawing
- Plans, sections and key elevations
- Material and colour palette
- Environmental strategy
- Illustrations of proposed built environment
- 3d images / CGIs

## Supplementary Information

- Supporting sketches and diagrams demonstrating the principles have been addressed
- Supporting reports (if applicable)

# Small Industrial Units



## A Strategic Approach to Parking

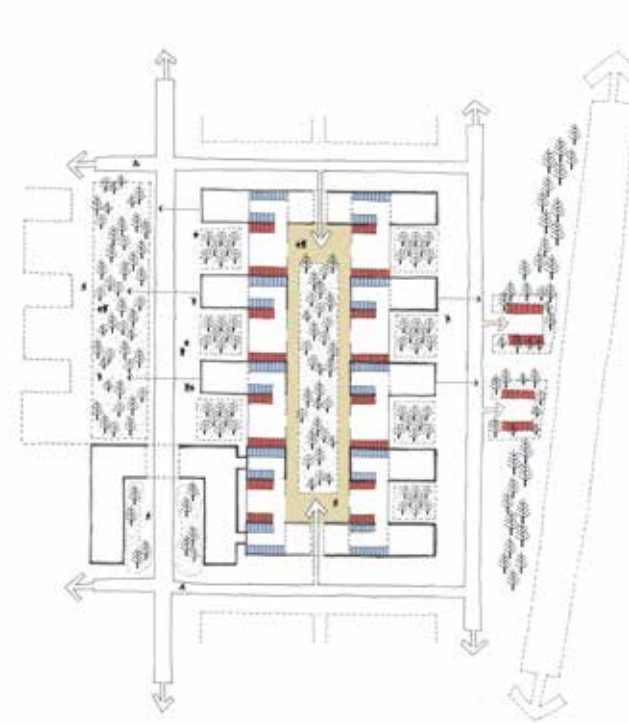

This diagram demonstrates how parking and servicing can be strategically concealed to help reduce the visual impact of it on the public realm. The smaller industrial units typically require smaller vehicles for deliveries and so the servicing can be concealed within the cluster of units.

- On Plot Parking
- Undercroft Parking
- Servicing

## An Integrated and Activated Public Realm

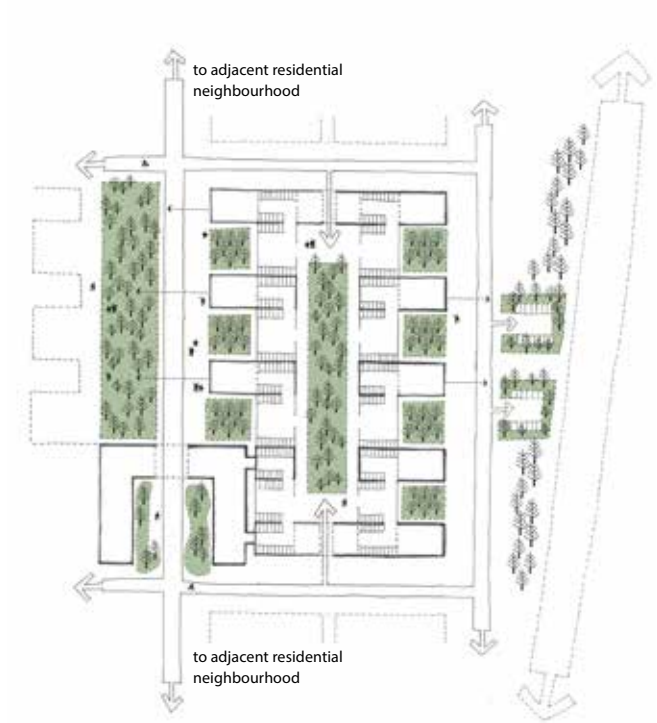

This diagram shows how green spaces form a focal point and are activated by organising the units around them. The built form provides an active frontage onto the landscaped spaces, which favour pedestrian activity.



# Large Industrial Units

## A Strategic Approach to Servicing

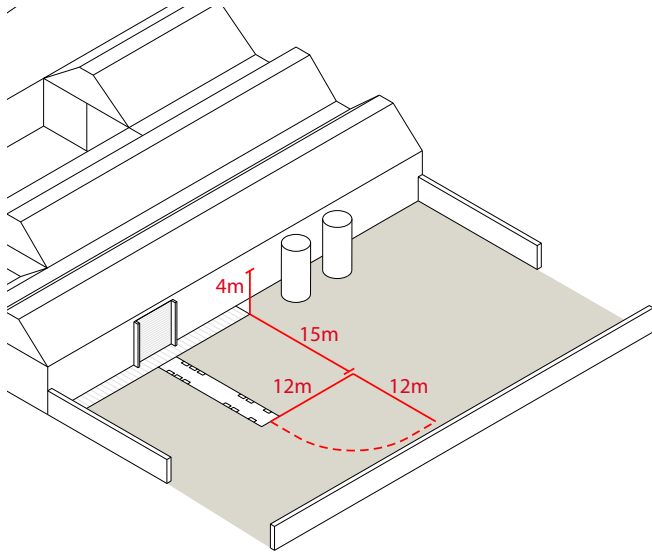

The diagram above provides an indicative example of how adequate space can be provided within the yard for HGV turning as well as vehicle bays. The roller shutter doors for deliveries have been designed with the height of vehicles in mind, and there is also a smooth surface for external movements provided just outside of the shutter door.

## A Clear Distinction of Street Types

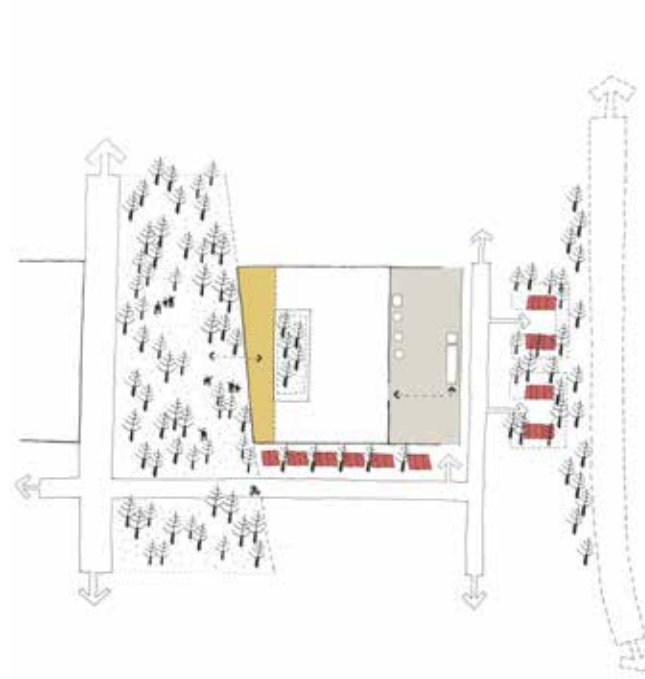

Dedicated loading and servicing space should be provided without causing much negative visual impact on the environment. Parking and servicing routes are discreetly located at the rear of the building, away from the primary pedestrian route and amenity space at the front.

- On Plot Parking
- Dedicated Service Area
- Social Hub

## An Integrated and Activated Public Realm

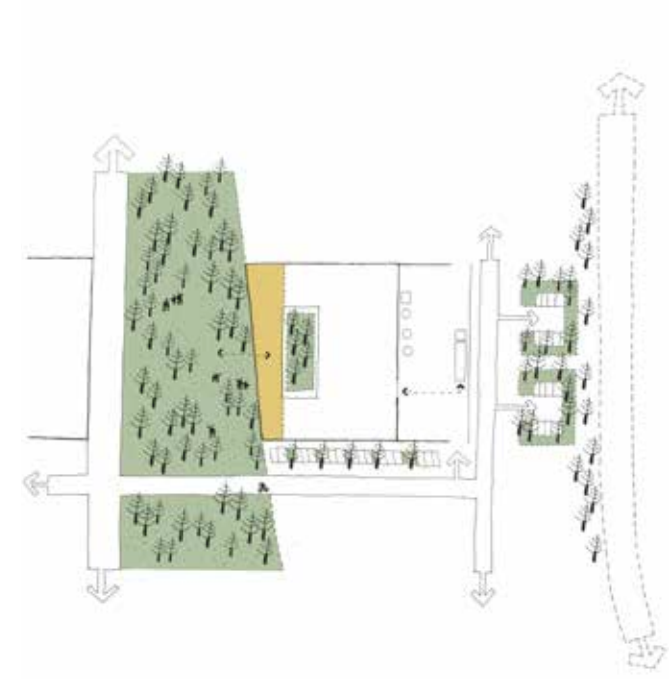

The public realm is pedestrian focused here and free of the large HGVs that are servicing the units. The amenity space / social hub fronts onto the landscape in order to encourage engagement of the new working community with the public realm.

# Industrial Units: Best Practice Examples

## Interface with Public Realm

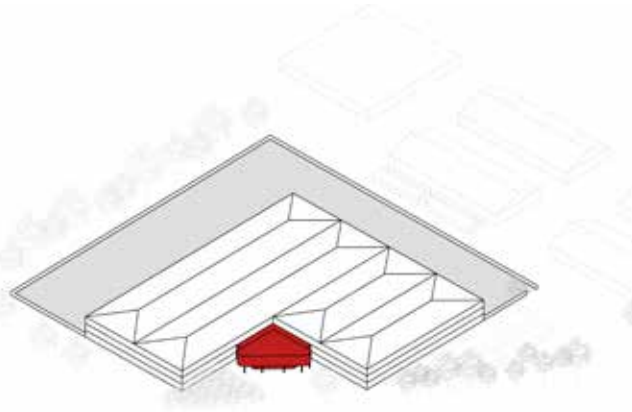

Example layout of Portal Mill Factory in Melksham showing clearly visible main entrance pavilion that faces the public realm

Photo: DBC



Entrance facing the public realm in Hemel Hempstead. Photo: DBC

## Interface with Public Realm (continued)



Example layout showing the social hub at the centre of the building, connecting the work space and public realm

Photo: DBC



Entrance area with social hub area on the ground floor at Maylands Business Centre. Photo: DBC

## Parking and Servicing

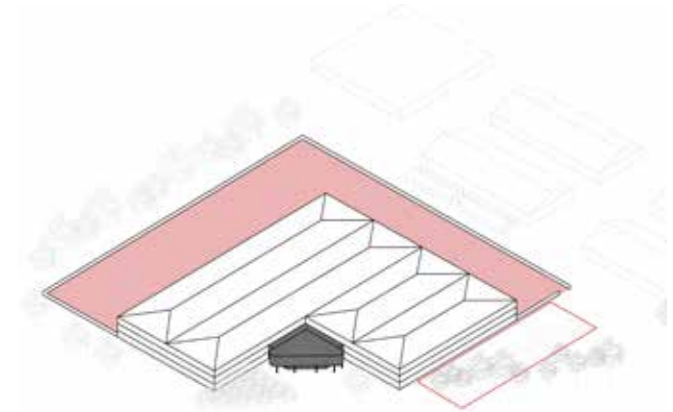

Example layout showing servicing and parking at the rear of the unit



Large, open workspace for manufacturing, assembling and storage served from the rear of the unit

### Parking and Servicing (continued)

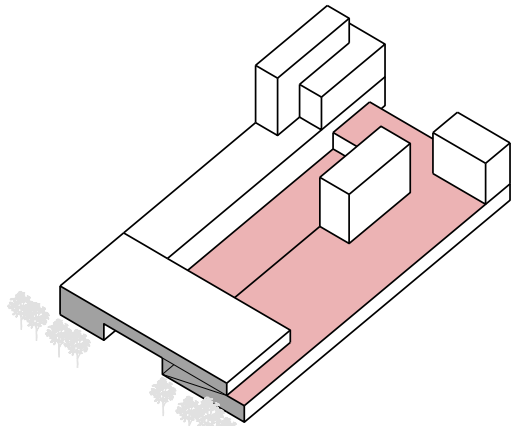

Parking and servicing is located within the unit's servicing court and on top of one of the roofs to the east

Kaap-Noord, Amsterdam. Vasco da Silva Architects & Planners



Large concealed servicing yard located off the main street

### Active Frontage and Interface with Public Realm

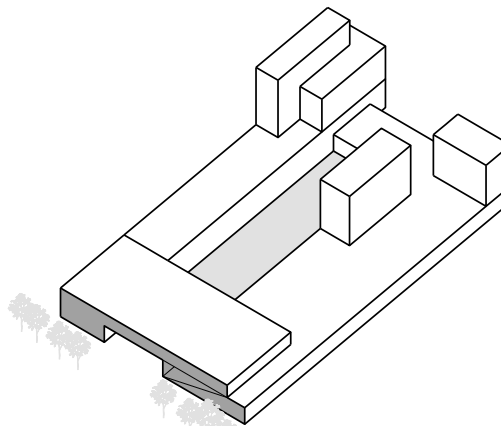

Example layout of Kaap Noord in Amsterdam showing an active frontage facing the public realm with the servicing concealed within the unit's court

Kaap-Noord, Amsterdam. Vasco da Silva Architects & Planners



Example showing attractive frontage facing the public realm with concealed servicing yard located at the back

### Active Frontage and Interface with Public Realm (continued)

Example layout of Tweedbank, Scottish Borders, showing servicing yards located at the back of the unit, concealed by walls, and the main entrance facing the public realm



Entrance space facing the public realm

# Small Office Units

## A Flexible and Adaptable Building

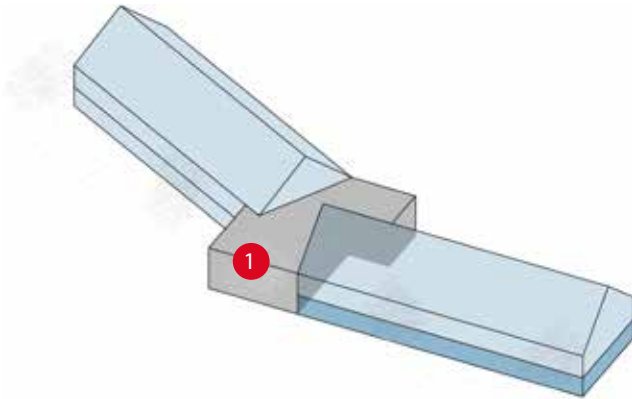

The diagram above shows how office accommodation can be arranged to create opportunities for collaboration and interaction between the users. A central hub space (labelled 1) accommodating shared facilities sits between flexible, shared workspaces that offer a blend of letting options.

## A Strategic Approach to Parking

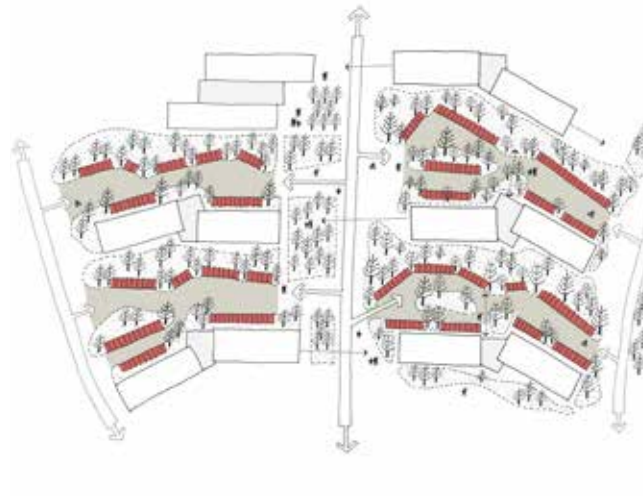

Smaller office units would not typically need large amounts of space for servicing and parking. The cartoon above shows how a shared surface could provide space for both parking and servicing. These areas are concealed within landscaped swaths of trees to minimise their visual impact.

- On Plot Parking
- Shared Surface

## An Integrated and Activated Public Realm



The diagram above demonstrates how a series of landscaped public realm spaces are used to link the development together, as well as connect it to adjacent neighbourhoods. The social spaces of the office units open onto landscaped spaces, in order to promote informal exercise and to foster interaction between workers and visitors alike.

# Large Office Units

## A Flexible and Adaptable Building

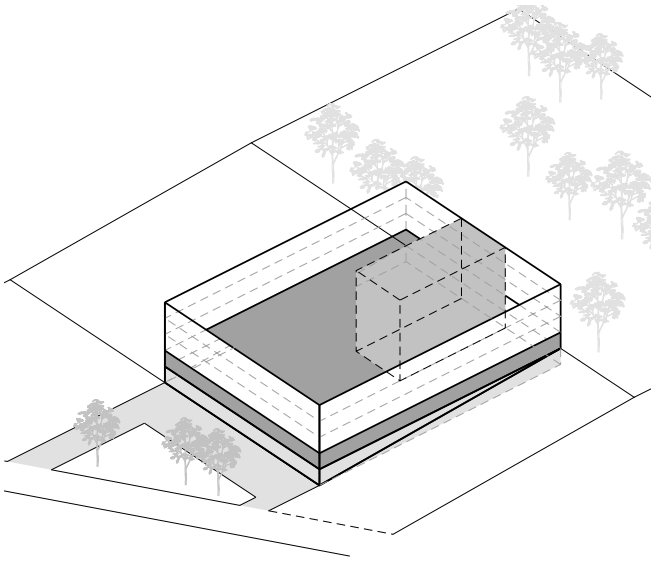

The diagram above demonstrates how a number of different uses can be stacked together within the same building and provide opportunities for collaboration between users. Parking and servicing is at the lower ground level, light industrial spaces at ground floor level and a mixed use, social atrium space links all the levels.

## A Strategic Approach to Parking

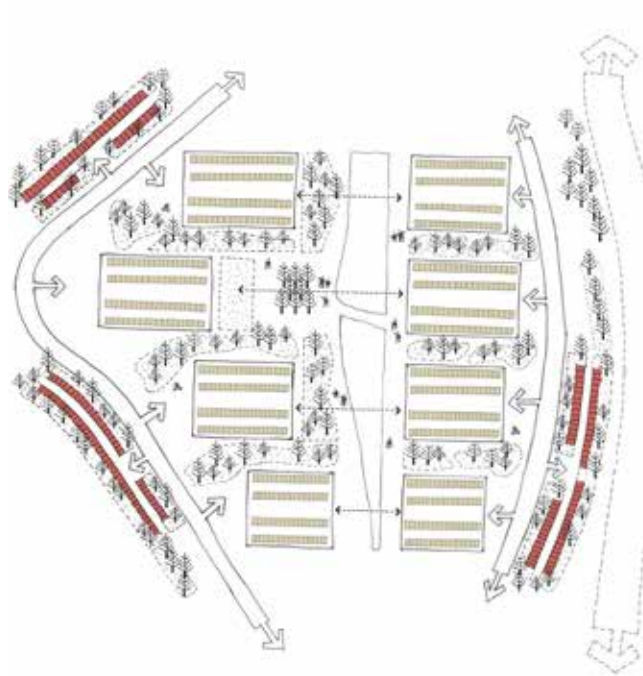

Larger office units typically need more space for parking as well as dedicated servicing areas. The cartoon above shows how parking can be concealed underneath the office units, whilst guest parking can be strategically clustered behind the units and between swathes of trees to minimise visual impact on the public realm.

- On Plot Parking
- Undercroft Parking

## An Integrated and Activated Public Realm



A clear focus has been shown in this diagram to organise the units around activated public spaces with a pedestrian focus to circulation within the public realm. As the parking has been concealed away to the edges, there is more space to incorporate areas of increased natural biodiversity between the office units.

# Office Units: Best Practice Examples

## Parking and Servicing



Smaller office units can strategically conceal parking and servicing at the back of larger units and within undercrofts, as seen at Chiswick Park

Chiswick Park, Hounslow. Rogers Stirk Harbour + Partners. Photo: Grant Smith



This means the frontage can be pedestrian focused and vehicle free

## Parking and Servicing (continued)

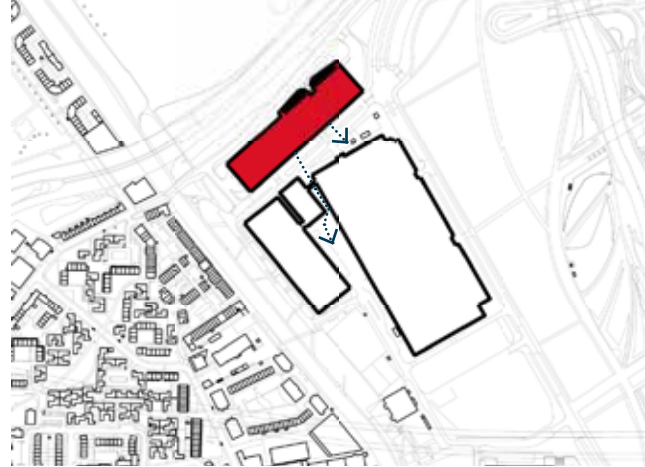

A parking barn is used at Here East, meaning the rest of the development can be parking free

Here East, Stratford. Hawkins\Brown. Photo: Jason Hawkes



As a result, the public realm can be parking free and pedestrian focused

## Building Arrangement

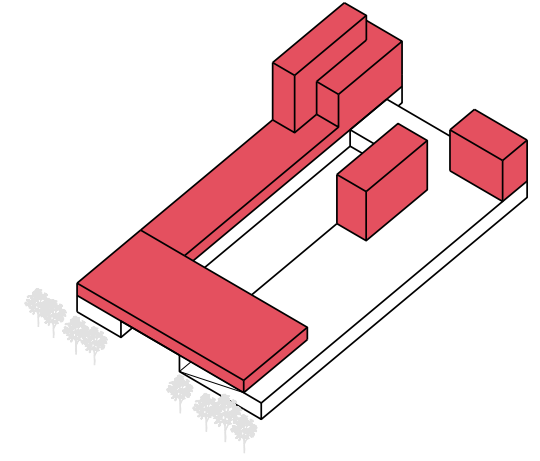

Buildings like Kaap Noord are flexible in their use of space, mixing different sized office spaces (red) with light industrial uses (white)

Kaap-Noord, Amsterdam. Vasco da Silva Architects & Planners



Light industrial uses are at the ground level with office units located above

## Interface with Public Realm

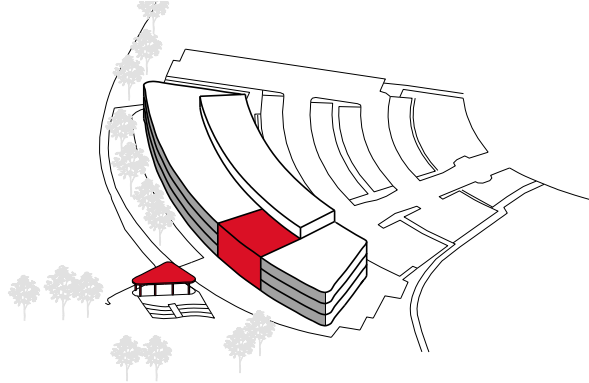

## Interface with Public Realm (continued)

At Cambridge Science Park, shared internal facilities (red) are located close to external facilities (red) to encourage engagement with the public realm

Bradfield Centre. Photo: Stace LLP



Example showing shared external pavilion / bar to encourage interaction between staff and visitors

Clear focus around a central landscape corridor at Green Park, Reading

Photo: Place Design Planning



Office units face inwards onto the public realm corridor